

Instructions

Melt Pressure Sensor

PT-DYN-E-1 Series



attestation

ISO 9001, 14001, 45001, 10002 & 31000

Please read this instruction manual carefully before installation



Content

1. Introduction
2. Application
3. Product features
4. Technical data
5. Dimensions
6. Electrical connection and debugging
7. Ordering Guide
8. Installation and Removal
9. Sensors cleaning
10. Transport and storage

Introduction

PT-DYN-E-X series adopt imported stainless steel materials, core elements and digital mode circuit design. Realizing sensor linear compensation through digital program. Remote autozero via shorting two pins together. Comply with SIL2, CE safety performance standards. High precision, high stability, low temperature drift and

Application

PT-DYN-E-X series is suitable for high-precision extrusion polymerization process control for sheets, composites, films, pipes, chemical raw materials, etc.

Product Features

- Several amplified signal output are optional
- Remotely auto zero
- Good stability and anti-interference ability
- Internal 80% self-calibration

Technical Data

Pressure Range	0~35bar ; 0~2000bar	0~100bar ; 0~2000bar	
Accuracy	±0.5% ; ±0.25%		
Over load Pressure	1.5FSO		
Bridge Resistance	350 Ω Wheatstone bridge		
Power	12~36Vdc (Standard24Vdc)		10Vdc
Output Signal	4~20mA	0~10Vdc / 0~5Vdc	3.33mV/V
Load Resistance ▲	<(U-12)/0.02	>10k	---
Calibration	80%FSO		
Process Connection	M14×1.5 , 1/2UNF , M18×1.5		
Insulation Resistance (50Vdc)	1000MΩ		
Diaphragm Material	17-4PH , inconel718 , C276		
Diaphragm Max Temp	400 °C		
Film Material	TiAlN		
E-connection	7-pin connector(Standard) , 8-pin connector		
Electrical Environment Temp	-20°C ~ 85°C		
Thermocouple	J Type , E Type , K Type , pt100		
Protection Degree	IP65		
Installation Torque	<30Nm		
Filing Material	Mercury filing		

Dimensions

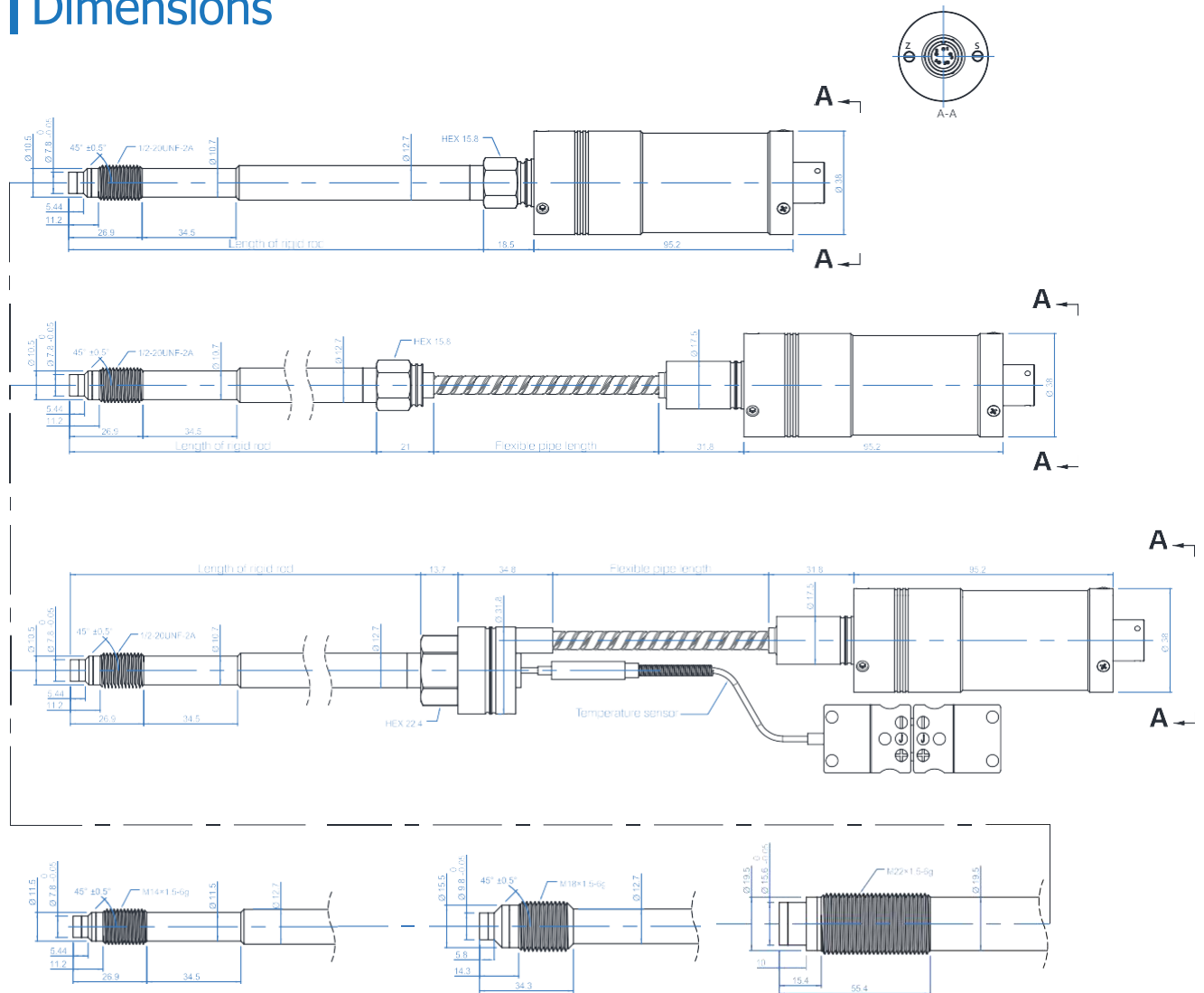

Electrical connection & Debugging

After the pressure sensor has been installed on the pipeline, the electrical connection must be made in accordance with the connection method shown in the wiring diagram below. The PT-DYN-E-X pressure sensor is equipped with an integrated amplifier circuit. The calibration process must be carried out when the pipeline is heated and the pressure is zero. The zero point is adjusted by activating the autozero function, which is started via shorting two pins together. Start by connecting (see wiring), mV signal does not have this function temporarily, it can be reset to zero through the back-end instrument. Then 80% of the output signal is detected (see wiring diagram), and the pressure sensor will provide a standard 80% measured value signal.

3.33mV/V Output (4-wire)

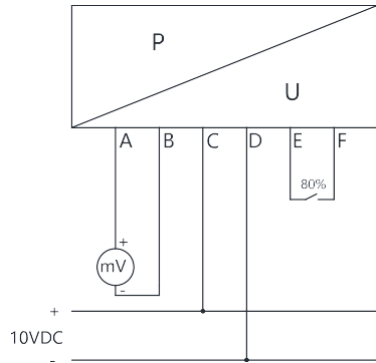

6-pin connector /PT02A-10-6P

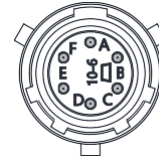

PIN	Function	Wire Color
A	Signal+	Red
B	Signal-	Black
C	Power+	White
D	Power-	Green
E	80%+	Blue
F	80%-	Orange

4-20mA Output (2-wire)

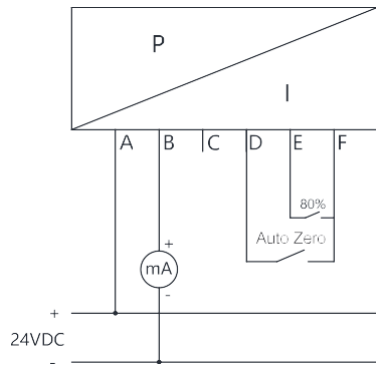

6-pin connector /PT02A-10-6P

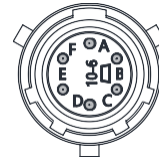

PIN	Function	Wire Color
A	Power+	Red
B	Power-	Black
C		White
D	Shorting D&F to rezero+	Green
E	80%+	Blue
F	Shorting D&F to rezero+/80%-	Orange

0-5V / 0...10V (4-wire)

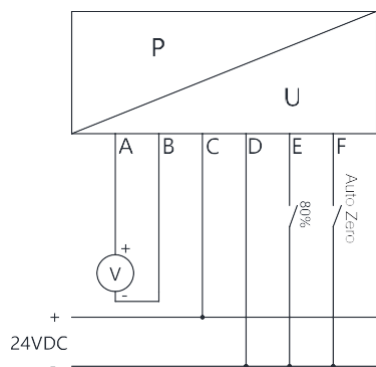

6-pin connector /PT02A-10-6P

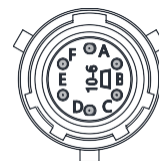

PIN	Function	Wire Color
A	Signal+	Red
B	Signal-	Black
C	Power+	White
D	Power- / 80%- / Shorting D&F to rezero-	Green
E	80%+	Blue
F	Shorting D&F to rezero+	Orange

*B and D pins are connected internally

It must be a shielded cable, each core wire is about 0.3mm², the heat-resistant temperature is not less than 105°C, each core wire connection terminal should be insulated and protected by heat shrinkable tube, the shielding wire should be connected with the plug-in metal, and the cable should be specially welded carefully, otherwise it may cause signal transmission errors or damage the product. It is recommended to use a dedicated cable that has been soldered by MPS. For extra wires in the cable, each wire needs to be individually wrapped with insulating tape.

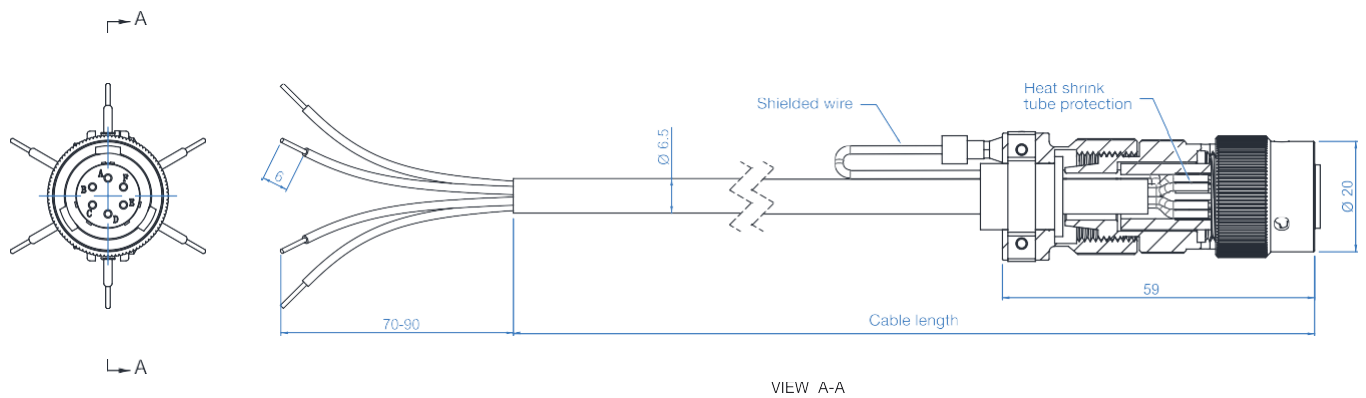

Installation & Removal

When installing the pressure sensor, the sensor hole should be within the size requirement marked in following drawing and the assembly accuracy can be checked by testing bolts. Before installing the sensor, first clean the impurities in the hole and between the threads, then the thread of the sensor is coated with heat-resistant slurry, the screw teeth can be avoided. The installation force is very important, the installation torque of the sensor can only act on the shaft (hexagon), do not apply any force to the head of the sensor. The housing should be kept away from high temperature areas.

1/2-20 UNF /M14×1.5= Maximum starting torque: 40Nm

M18 x 1.5 = Maximum starting torque: 50 Nm

Flange installation=Maximum starting torque: 50 Nm

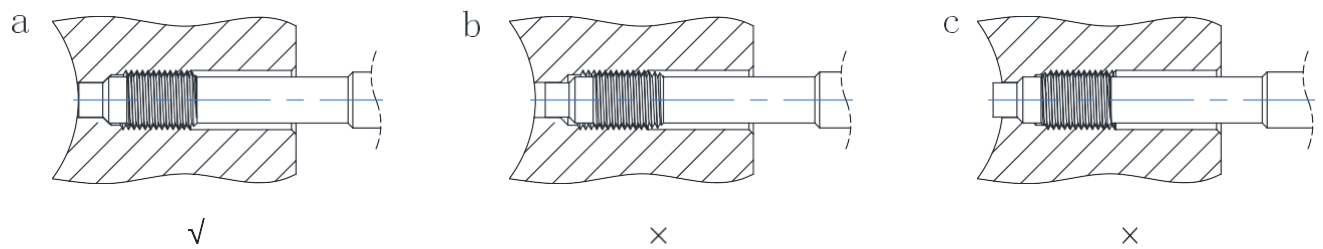

Removal

The removal of sensor must be done under heated conditions (plastic melting point). When remove the sensor, please note that the diaphragm has no contact pressure. The force to remove the sensor must only be applied on the shaft (hexagon), and do not apply any force to the head of the sensor.

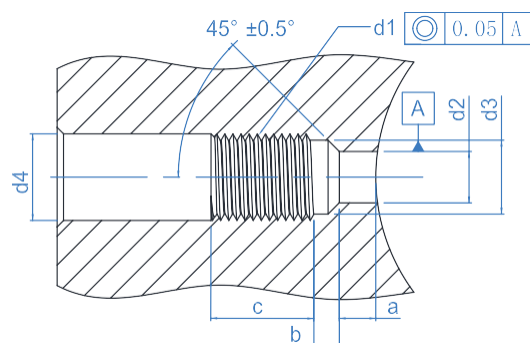

d1	M18×1.5	M14×1.5	1/2-20UNF-2A
d2	∅ 9.9 ^{+0.1}	∅ 7.9 ^{+0.1}	∅ 7.9 ^{+0.1}
d3	∅ 16.1 ^{+0.1}	∅ 11.7 ^{+0.1}	∅ 10.7 ^{+0.1}
d4	∅ 20	∅ 15	∅ 14
a	6.1 ^{-0.1}	5.7 ^{-0.1}	5.7 ^{-0.1}
b	4 ^{-0.2}	3.2 ^{-0.2}	3.2 ^{-0.2}
c	25	19	19

| Sensors cleaning

In order to clean the diaphragm, the sealing surface and thread of the sensor must have the same temperature as the melting point of the plastic. Both the diaphragm and the sealing surface can be wiped clean with a soft cloth, and the thread can be cleaned with a steel brush or a copper brush.

(Do not touch the surface of the diaphragm with the steel brush.)

| Transport and storage

The PT-DYN-E-X series is usually packaged separately. The front thread of the rigid stem and the diaphragm is protected by a protective cap. This protective cap should be tightened at any time during storage, and only opened during installation.

Note: Mounting brackets, extension cables, connectors, cleaning kits, drill kits, dummy plug etc accessories, please contact with us.